

**durotuf**<sup>®</sup>

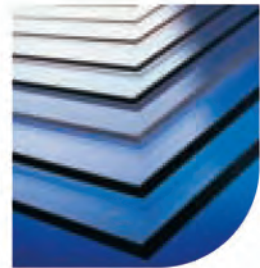

**marlon fs**<sup>®</sup>

Solid Polycarbonate Sheet



Brett Martin's sheet products are respected around the world for their record in the construction industry.

The Marlon range of polycarbonate sheets represent ideal solutions in structured, corrugated and flat forms for a wide range of applications and projects. Marlon flat sheet is the most versatile of these materials offering the very highest levels of glazing performance.

# marlon fs<sup>®</sup>

## POLYCARBONATE



Durability and design freedom are two of the key features which designers seek when selecting modern materials. Marlon flat sheet offers both features plus many more benefits over traditional glazing and fabrication alternatives.

**Marlon FS** is clearly transparent, maximising light transmission when required and through tints can also offer solar control. The strength of polycarbonate is now legendary, with unbeatable impact resistance, yet it remains flexible enough to be cold curved on site for curved applications.

For use in the world's toughest climatic conditions we have developed **Marlon FSX Longlife** featuring co-extruded UV protection on both sides of the sheet, which enhances its weather resistance and performance.

**Marlon FS Hard** combines high levels of abrasion and chemical resistance with the quality, optical clarity and outstanding impact resistance of Marlon FS.

Together these features represent an unequalled combination of properties in a material manufactured to the highest international quality standards.



# Glazing

Marlon flat polycarbonate sheet offers a superior glazing solution to that of other materials, particularly when safety or impact resistance is of vital importance.

The criteria for safe, attractive and practical glazing in hospitals, schools, sporting facilities and other public areas are easily met through the use of Marlon flat sheet.



## Safety

With an impact strength up to 200 times greater than glass, Marlon flat sheet remains virtually unbreakable, offering protection for those working or playing beneath it.

## Design Flexibility

Marlon flat sheet can easily be cold curved on site, enabling the designer to create interesting glazing solutions for a bright, naturally lit interior environment. Marlon flat sheet provides light transmissions of up to 90%.

## Economy

Resistance to breakage through vandalism can dramatically reduce a building's maintenance costs and, in addition, Marlon flat sheet can help reduce energy costs through its superior thermal properties over glass.

## Durability

Marlon flat sheet has excellent resistance to the weather and atmospheric conditions. Marlon FSX Longlife grade sheet offers a guarantee for continued performance in prolonged outdoor exposure.

## Practicality

The weight of Marlon flat sheet is only half that of plate glass, making handling and installation ultimately more convenient. The sheets can be installed or fabricated with the minimum of specialist tools or labour.

## Quality

Marlon flat sheet is manufactured by Brett Martin in its state of the art extrusion facility complying with international quality standards certified to BS EN ISO 9001:2000.

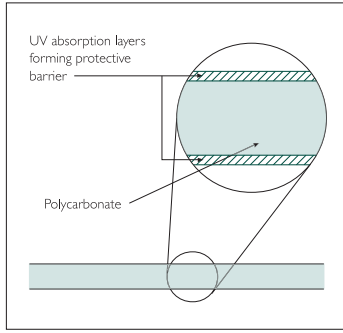

**Co-extruded UV Protection**

Marlon FSX Longlife has a high performance UV absorption layer co-extruded on both surfaces which prevents damaging UV radiation from penetrating the sheet. UV protection means longer life, preventing yellowing and loss of strength. It cuts out 98% of harmful UV radiation, protecting those working or playing beneath it.

**Warranty**

Marlon FSX Longlife carries a guarantee against light transmission and breakage as outlined in the warranty statement, available separately.

**Fire Performance**

Marlon flat sheet offers good fire performance, up to Class 1 surface spread of flame.



**Abrasion Resistance**

An innovative protective coating provides Marlon FS Hard with enhanced resistance to marks and scratches compared to standard polycarbonate. It is suitable for use where enhanced protection against damage is needed.

**Abrasion Tests**

Taber abrasion - Test: ASTM D1044 - 78  
Resistance of transparent plastics to surface abrasion. This is the most controlled and most widely accepted method for testing the abrasion resistance of a transparent substrate.

Test: CS 10 F abrasion wheels with a 500g load are run across the sheet 100 times. The results are measured using a haze measurement test: ASTM D1003 Test for haze and luminous transmittance of transparent plastics.

HAZE CHANGE %	
Uncoated Polycarbonate	29.5
Marlon FS Hard	3.6

**Chemical Resistance**

The hard gloss finish of Marlon FS Hard has been specially formulated to withstand contact from a wide range of cleaning agents and organic solvents, a major advantage over standard polycarbonate. After attack from 'graffiti artists' Marlon FS Hard can be cleaned.

**Warranty**

Marlon FS Hard has a 10 year breakage warranty and a limited 5 year coating warranty.

CHEMICAL RESISTANCE SOLVENT	MARLON FS HARD POLYCARBONATE
Ethanol	Long
Propanol	Long
Acetone	Short
MEK	Long
Petrol	Long
Dilute Ammonia	Medium
Dilute Caustic Soda	Short
Concentrated Caustic Soda	Short
Dilute Organic Acid	Long
Dilute Inorganic Acid	Long
<b>Short Term Resistance</b>	drops/spills
<b>Medium Term Resistance</b>	up to 8 hrs
<b>Long Term Resistance</b>	no attack

**RANGE**

SHEET SIZE (mm)	SHEET THICKNESS (mm)	
<b>Marlon FS</b>	1220 x 2440	3, 4, 5, 6
	2050 x 1250	3, 4, 5, 6
	2050 x 2500	2, 3, 4, 5, 6
	2050 x 3050	2, 3, 4, 5, 6, 8, 10, 12
<b>Marlon FSX Longlife</b>	1220 x 2440	3, 4, 6
	2050 x 1250	2, 3, 4, 5, 6, 8, 10, 12
	2050 x 3050	2, 3, 4, 5, 6, 8, 10, 12
<b>Marlon FSX Textured</b>	2050 x 3050	3, 4, 6
<b>Marlon FS Hard</b>	2000 x 3000	3, 4, 5, 6, 8, 10, 12

Brett Martin constantly reviews its standard ranges. Please contact your distributor for the latest range availability. The entire range is available in clear and several sizes and thicknesses in tints. Tinted options can be manufactured in all sizes but are subject to minimum order quantities. Numerous variations are possible and Marlon flat sheet can be manufactured to meet special requirements.\* Do not hesitate to contact your distributor to discuss your particular requirements.

\* Bespoke orders will be subject to a minimum order quantity.





# Applications



**marlon fs**<sup>®</sup>

**marlon fsx**<sup>®</sup>  
LONGLIFE

**marlon fs**<sup>®</sup>  
HARD

Marlon flat sheet can be used in a variety of applications which require its high performance features.

These include general glazing, roofing, safety glazing, protective screening, visors and fabrication for interior and exterior uses.

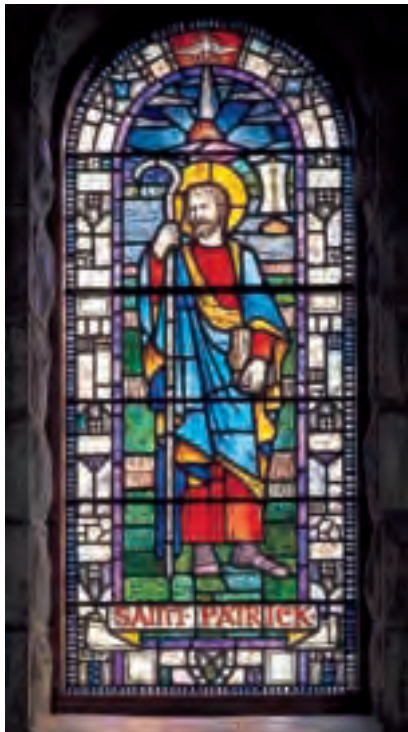

3



4



5



6



7



8



9

1. VAULT ROOFLIGHTS 2. CURVED ROOFS 3. ANTI-VANDAL SECONDARY GLAZING 4. DOME ROOFLIGHTS 5. MACHINE GUARDS  
6. ARCHITECTURAL FEATURES 7. PROTECTIVE CASINGS 8. PROTECTIVE VISORS 9. SHELTERS

PROPERTIES

PROPERTIES	TEST METHOD	UNITS	VALUE
<b>Physical</b>			
Density	DIN 53479	g/cm <sup>3</sup>	1.2
Light Transmission (3mm thick, clear)	DIN 5036	%	88
Refractive Index	DIN 53491		1.585
<b>Mechanical</b>			
Tensile strength at yield	DIN 53455	N/mm <sup>2</sup>	>60
Tensile strength at break	DIN 53455	N/mm <sup>2</sup>	>70
Modulus of Elasticity	DIN 53457	N/mm <sup>2</sup>	2300
Impact strength @ 23°C (notched Charpy)	DIN 53453	kJ/m <sup>2</sup>	>30
<b>Thermal</b>			
Linear Expansion Coefficient		1/K	68 x 10 <sup>-6</sup>
Thermal conductivity	DIN 52612	W/mK	0.21
Heat deflection Temperature Load 1.81 N/mm <sup>2</sup>	DIN 53461	°C	135
Maximum continuous service temperature		°C	100

Fire Performance

COUNTRY	THICKNESS (mm)	TEST METHOD	CLASSIFICATION	CERTIFICATE NO.
UK	3	BS2782: 1970: Method 508A		WARRES No. 56933
UK	3	BS476: Part 7: 1987	Class 1Y	WARRES No. 66300
France	3	892/2002	Class M2	5120606-DMAT/1
Germany	3	P-MPA-E-00-612	Class B1	16-22633/1
UK	3 (embossed)	BS476: Part 7: 1987	Class 1Y	WARRES No. 70651

Light Transmission to DIN 5036 (%)

COLOUR CODE	1mm	2mm	3mm	4mm	5mm	6mm	8mm	10mm	12mm
Clear S	90	89	88	87	86	86	86	84	82
Clear S (Embossed)	-	-	84	83	82	81	77	-	-
Bronze CE	-	-	54	53	54	54	53	51	-
Green CF	-	-	41	38	-	41	-	-	-
Blue LM	-	-	-	-	-	14	-	-	-
Opal FH	-	-	37	32	31	26	-	-	-
Grey IM	-	-	-	33	-	35	-	-	-

With light transmission of between 82% and 90%, clear Marlon flat sheet offers excellent clarity.

Thermal Transmittance - U Value

THICKNESS (mm)	MARLON FSX (W/m <sup>2</sup> K)	GLASS (W/m <sup>2</sup> K)
2	5.56	-
3	5.41	5.87
4	5.27	5.82
5	5.13	5.80
6	5.00	5.77
8	4.76	5.71
10	4.55	-
12	4.35	-

Marlon flat sheet has a 'U' value and therefore heat loss significantly lower than glass.

Weight

THICKNESS (mm)	MARLON FLAT SHEET (kg/m <sup>2</sup> )	GLASS (kg/m <sup>2</sup> )
2	2.4	5.00
3	3.6	7.50
4	4.8	10.00
5	6.0	12.50
6	7.2	15.00
8	9.6	20.00
10	12.0	25.00
12	14.4	30.00

At just about half the weight of glass, Marlon flat sheet offers savings in handling, transportation and installation.

Tensile Strength

Measured on injection moulded test specimens.

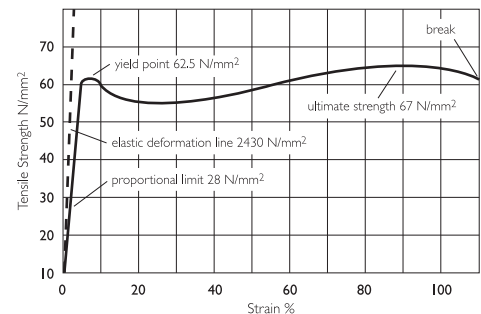

Thermal Expansion

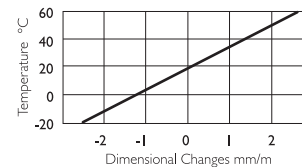

Flexural Modulus vs Temperature

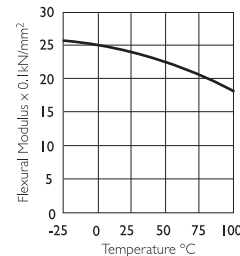

Tensile Strength vs Temperature

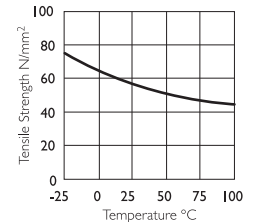



## FABRICATING GUIDELINES

### CUTTING

Marlon flat sheet is easy to saw and cut on standard workshop equipment. It can be machined on conventional milling machines with standard high speed tools. Notches adversely affect the mechanical properties of polycarbonate and should be avoided.

RECOMMENDATIONS	CIRCULAR SAW	BAND SAW	MILLING MACHINE
CLEARANCE ANGLE	20-30°	20-30°	20-25°
RAKE ANGLE	15°	0.5°	0-5°
CUTTING SPEED	1800-2400 m/min	600-1000 m/min	100-500 m/min
FEED SPEED	19-25 m/min	20-25 m/min	0.1-0.5 mm/rev
TOOTH SPACING	2-5 mm	1.5-2.5 mm	-

### DRILLING

Any commercially available metal drill without a specially ground bit is suitable for use with Marlon flat sheet.

#### Drill Data

PARAMETER	VALUE
Clearance angle $\alpha$	5-8°
Tip angle $\varphi$	90-130°
Helix angle $\beta$	ca 30°
Rake angle $\gamma$	3-5°
Cutting speed	0.1-0.5mm/rpm
Drill tip speed	10-60m/min

The following points should be observed when drilling Marlon flat sheet:

- Do not use cutting oils with Marlon flat sheet
- The sheet may break as a result of notching
- Fixing threads should only be used if there is no other alternative (through-hole, bonding, clamping)

**NB** - The hole should be at least 1.5 x hole diameter from the sheet edge.

### THERMOFORMING & HOT BENDING

Before thermoforming, remove masking films and pre-dry at 120°C to remove absorbed moisture. Air circulation ovens with accurate temperature control are most efficient - air must circulate

between sheets. Sheet age and storage conditions determine drying time. Dry storage can reduce pre-drying time in oven by up to one third - some experimentation is usually necessary. As moisture re-absorption starts when the dried sheet temperature falls below 100°C, thermoforming should be performed immediately after drying. Pre-drying is not normally required when hot line bending.

#### Guidelines for Drying

SHEET THICKNESS (mm)	DRYING TIME AT 120°C (hr)
2	4
3	8
4	13
5	18
6	24
8	38
10	30
12	33

Marlon flat sheet can be moulded on any standard vacuum or pressure forming equipment. Forming can be made at temperatures between 175°C and 200°C. When the mould temperature falls below 125°C formed parts can be removed. Mould shrinkage will be between 0.5% and 1.0%.

The recommended temperature for hot bending is between 155°C and 165°C. Marlon FS Hard cannot be thermoformed.



### COLD CURVING

Marlon flat sheet can easily be cold curved. At low radii high stresses are built up in the material which will lower chemical resistance. Radii should be as large as possible to minimise stresses.

The minimum allowable radius for cold curved applications is SHEET THICKNESS x 150. This incorporates a factor of safety to cope with the stress effects produced by curving and environmental stress factors. Marlon FS Hard must be curved to a radius more than 1500mm.

### BONDING

The material can be bonded using one of the following adhesives; Epoxy, Polyurethane, Hot Melt or Silicone. Ask your adhesive supplier for the most appropriate type of adhesive for your particular application. Solvents such as Methylene Chloride give a good bond but can lead to stress cracking and are therefore not recommended.

### CLEANING

A mild detergent with lukewarm water and a soft cloth or sponge should be used to clean Marlon flat sheet. Always rinse thoroughly with clean water. Ethyl Alcohol can be used to remove paint and other such substances. This should always be washed and rinsed thoroughly afterwards.

## GENERAL INSTALLATION

Marlon flat sheet can be installed in most types of frames including PVC, wood, steel and aluminium. The framing system must retain the sheet but allow thermal movement.

Only compatible sealants must be used, these include silicone, EPDM, neoprene or 'plasticiser free' chloroprene materials of proven performance. Please note that PVC gaskets are not compatible with polycarbonate.

### EXPANSION ALLOWANCE

Care must be taken when cutting sheets to allow space for thermal expansion to avoid stress or bowing with temperature change (see table below). Allowance must be made in both length and width. In vertical installations the expansion allowance must be left at the top of the frame and at both sides.

#### Expansion Allowance

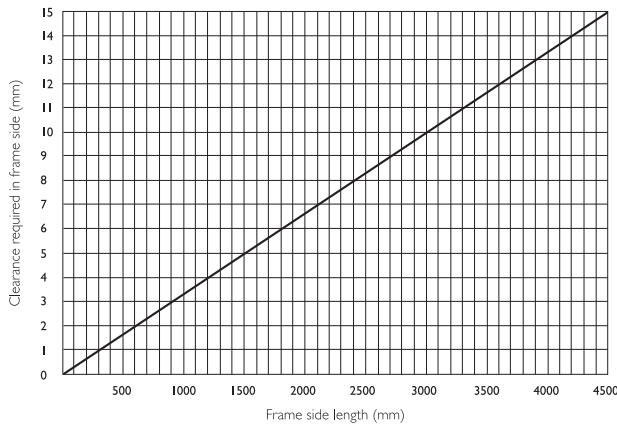

### SHEET SIZING

Use the table below to calculate the required trimming of Marlon flat sheet to allow for expansion dependent on the sash dimensions.

SASH DIMENSIONS 'F' mm	TRIM MARLON FLAT SHEET BY 'E' mm
300-1000	3 mm
1000-1300	4 mm
1300-1700	5 mm
1700-2000	6 mm
2000-2300	7 mm
2300-2700	8 mm
2700-3000	9 mm

### EDGE ENGAGEMENT

Each rebate detail must allow enough depth to include the expansion allowance plus a sufficient sheet edge engagement to prevent sheet 'pop-out' from the frame.

#### Rebate depth 'R' and edge engagement 'G'

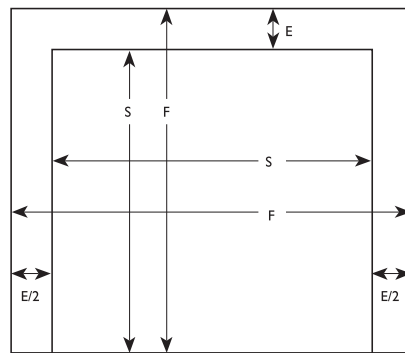
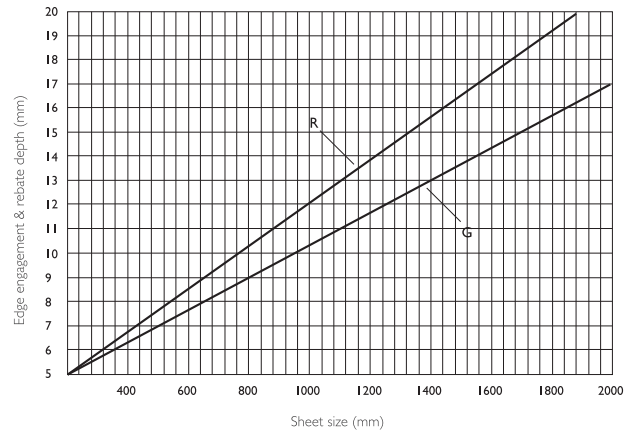

#### Window Section

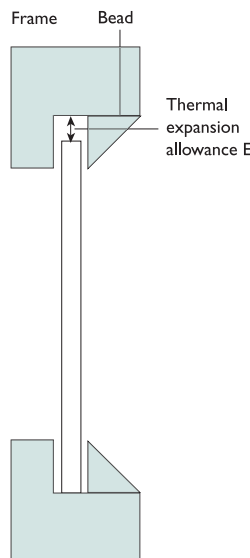

#### Frame Section

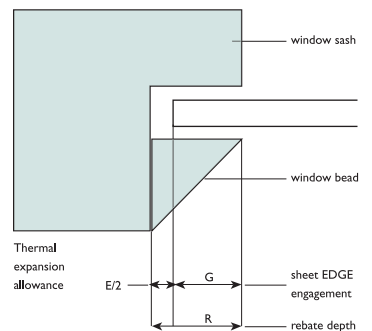

## SHEET THICKNESS

The following charts indicate the required sheet thickness to maintain sheet deflection to a maximum of 50mm and assumes four side edge engagement. Having first calculated the effective area of the sheet, the required thickness for a given wind load can be selected. Guidance is also available from BS5516.

### Calculation of the Effective Sheet Area

Sheet Width (m)	Sheet Length (m)																			
	0.25	0.5	0.75	1.0	1.25	1.5	1.75	2.0	2.25	2.5	2.75	3.0	3.25	3.5	3.75	4.0	4.25	4.5	4.75	5.0
0.25	A1	A1	A1	A1	A1	A1	A1	A1	A1	A1	A1	A1	A1	A1	A1	A1	A1	A1	A1	A1
0.5	A1	A2	A3	A4	A4	A4	A4	A4	A4	A4	A4	A4	A4	A4	A4	A4	A4	A4	A4	A4
0.75	A1	A3	A5	A6	A7	A7	A7	A7	A7	A7	A7	A7	A7	A7	A7	A7	A7	A7	A7	A7
1.0	A1	A4	A6	A8	A9	A9	A9	A10	A10	A10	A11	A11	A11	A11	A11	A11	A11	A11	A11	A11
1.25	A1	A4	A7	A9	A10	A11	A12	A13	A13	A14	A14	A14	A14	A14	A14	A14	A14	A14	A14	A14
1.5	A1	A4	A7	A9	A11	A13	A14	A15	A16	A16	A16	A17	A17	A17	A17	A17	A17	A17	A17	A17
1.75	A1	A4	A7	A10	A12	A14	A16	A17	A18	A19	A19	A19	-	-	-	-	-	-	-	-
2.0	A1	A4	A7	A10	A13	A15	A17	A18	A19	-	-	-	-	-	-	-	-	-	-	-

### Selection of Sheet Thickness in mm

Load kN/m <sup>2</sup>	Effective Area																		
	A1	A2	A3	A4	A5	A6	A7	A8	A9	A10	A11	A12	A13	A14	A15	A16	A17	A18	A19
0.6	3	3	4	4	5	5	6	6	8	8	10	10	10	10	10	10	12	12	12
0.8	3	3	4	4	5	6	6	6	8	8	10	10	10	12	12	12	12	12	-
1.0	3	4	4	5	5	6	8	8	8	10	10	10	10	12	12	12	-	-	-
1.2	3	4	4	5	5	6	8	8	8	10	10	10	12	-	-	-	-	-	-
1.4	3	4	5	6	6	8	8	8	10	10	12	12	-	-	-	-	-	-	-

## CURVED INSTALLATION

Marlon flat sheet can be installed in a curved glazing system on site, without prior forming. The thickness of sheet that must be used will depend upon the curvature and the span, the distance between glazing bars and the maximum load that will be applied to the sheets.

Each sheet thickness has a minimum allowable radius.

THICKNESS 't' (mm)	MINIMUM RADIUS 'r' (mm)
2	300
3	450
4	600
5	750
6	900
8	1200
10	1500
12	1800

FS Hard minimum radius (all thicknesses) = 1500mm

The critical load at which buckling will occur is a function of the geometry of the structure and the intrinsic properties of Marlon flat sheet.

A safety factor of 1.5 is applied in all cases.

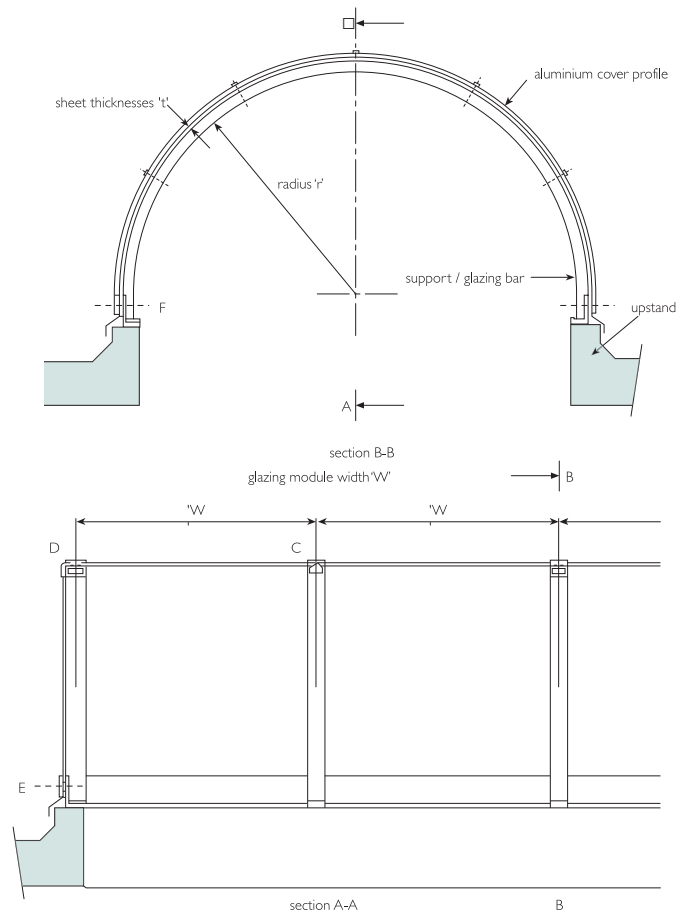



**Head Office - Cape Town**

Libra Close , Brackenfell  
Tel 021 981 1440  
Fax 021 981 1541

**Gauteng**

Cnr Northway Marlboro Drive  
Kelvin , Sandton  
Tel 011 804 2804  
Fax 011 804 2808

**George**

Cnr Fabriek / Albert Rd  
George Industria  
Tel 044 873 0508/3  
Fax 044 873 0503

web site : [www.duroplastic.com](http://www.duroplastic.com) • e-mail : [sales@duroplastic.com](mailto:sales@duroplastic.com)

